

EPIC

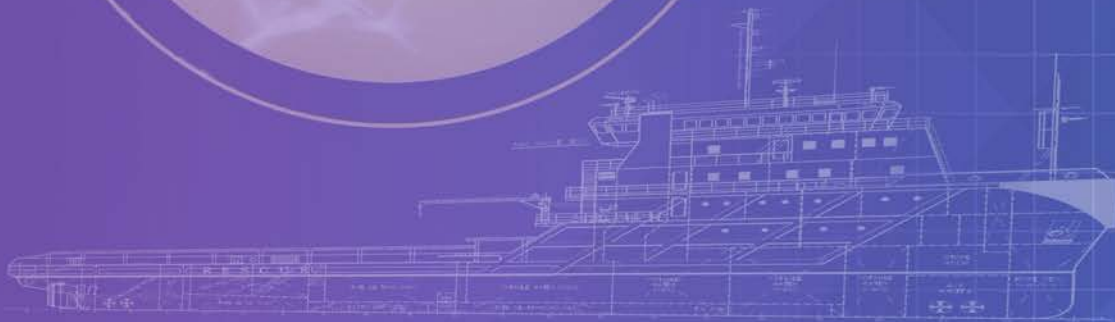

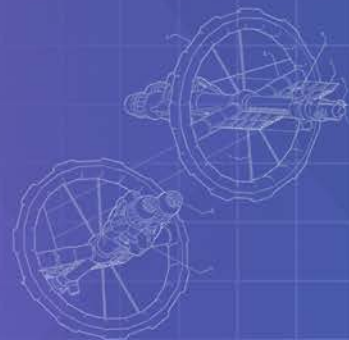
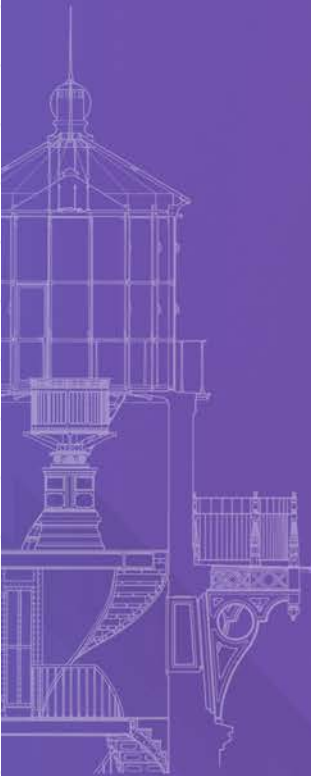
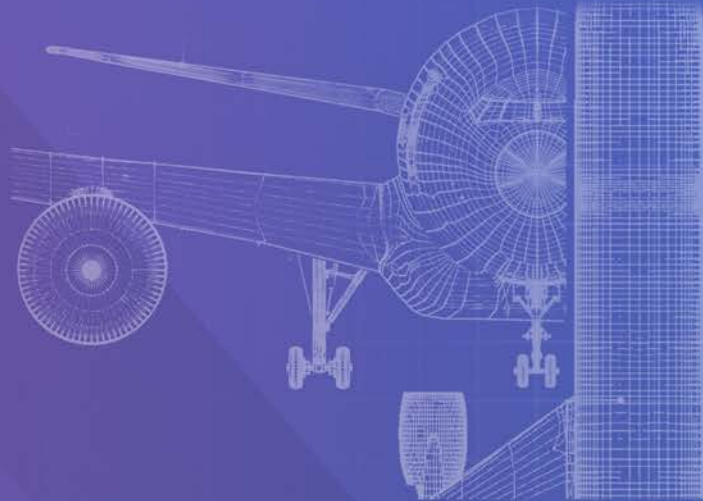

INTRODUCTION

EPIC was established in the year 2017 under the partnership of two leading Groups “Hussein Al Haddad Group of Companies” and “Al Obaidani Group of Companies”. These two groups are owned and managed by two leading Omani businessmen in the country and it focuses on building diverse spectrum of products, services and solutions combined with creativity, passion, expertise and modern technology to its customers not only in the Sultanate of Oman but also to other GCC countries.

Each of this Group have set themselves as a dynamic organization that ventures itself into diversified portfolios to heighten its capabilities and contribute 100% towards the growth of in-country value for the Sultanate of Oman. There are several companies under each group and a brief about these companies and the brands they represent are given on the last pages of this profile and EPIC being one of the group companies offers a wide array of services and solutions in the sectors of:

- ◆ Marine
- ◆ Aviation
- ◆ Solid Waste and Water Sustainable Management
- ◆ Infrastructure Development
- ◆ Green Hydrogen

Each sector has its own partner companies that bring vast experience, connections and business intelligence. The success formula of EPIC is that it never fails to explore and develop new synergies and opportunities to keep it growing, updating itself with the changing global business and customer requirements. EPIC’s Team is extensively working in venturing into several other business portfolios in partnership with international companies across the Globe.

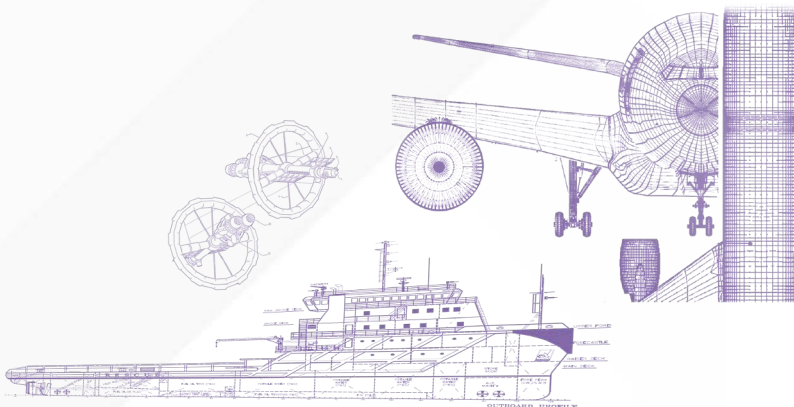
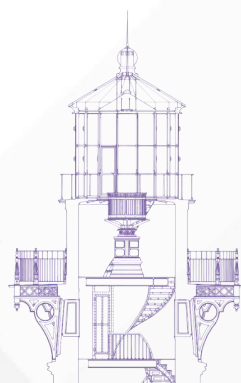
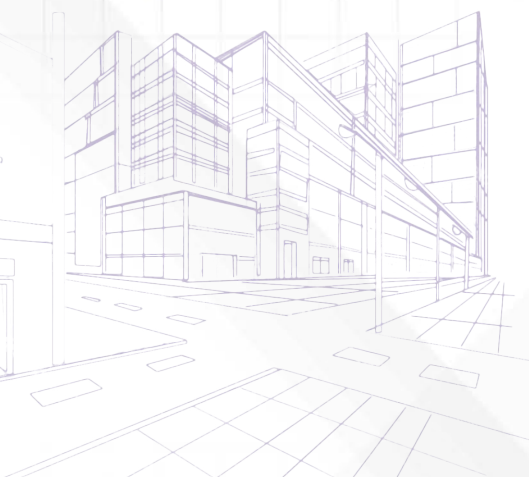

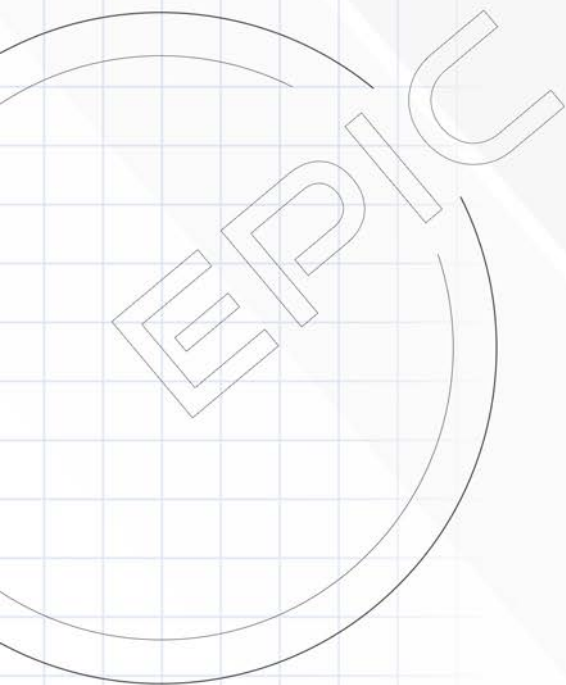

VISION

To support our clients with the aim of building long term business relationships



MISSION

Provide simple, efficient, trustworthy solutions to our clients with untiring professionalism



CORPORATE VALUES

- ◆ Collaboration and Partnership
- ◆ Integrity
- ◆ Innovative
- ◆ Respect
- ◆ Customer Commitment
- ◆ Diversity

SECTORS THAT WE SERVE

1. Marine Sector



2. Aviation Sector



3. Water Sustainable Management



Partner company ,

Deyyar International LLC



Partner companies ,

1. Reed Bed

2. EPPM



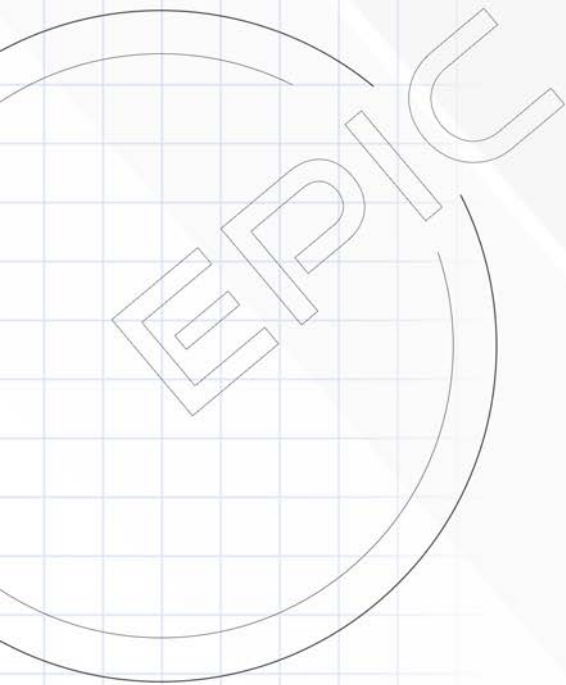

4. Infrastructure Development



Partner company ,

China Communications Construction Company Ltd



5. Green Hydrogen



Partner company ,

Golden Wellspring Wealth
for Trading LLC

شركة نبع الثراء الذهبية للتجارة ش.م.م





MARINE SECTOR

We offer brokerage services, leasing, sales and remarketing of ships and act as intermediaries and negotiators between buyers and sellers.

We as brokers can link two parts of the chain; ship-owner and charterer, and more generally, seller and buyer, in such a way that meets their demands.

We are specialist brokers / intermediaries / negotiators between ship-owners and charterers or between buyers and sellers of vessels. We bring at your disposal our vast experience, connections, expertise and business intelligence in the field of ship brokerage. Tailored services, end to end connection, new and existing rules updating is what we bring to our customers. We explore and develop new synergies and opportunities to keep ourselves up to date with changing global market requirements.

Our ability to provide clients with the most competitive and realistic prices and contracts makes us stand out from the rest. Our experts can plan, budget and advise on existing and upcoming projects avoiding any potential disputes and can mediate where necessary.



SERVICES THAT WE OFFER

- ◆ Detailed negotiation of the Charter – Party terms and conditions
- ◆ Commercial management of vessels
- ◆ Mediation of deals
- ◆ Package-deals' arrangement (Tailor-made solutions)
- ◆ Contact ship agents, notification / appointment of cargo-surveyors
- ◆ Advice and support on legal shipping matters, demurrage agreements and lawsuits
- ◆ Access to freight rates, market statistics, availability of cargo and tonnage
- ◆ General supplies for the vessels.



DIVISIONS THAT WE SERVE

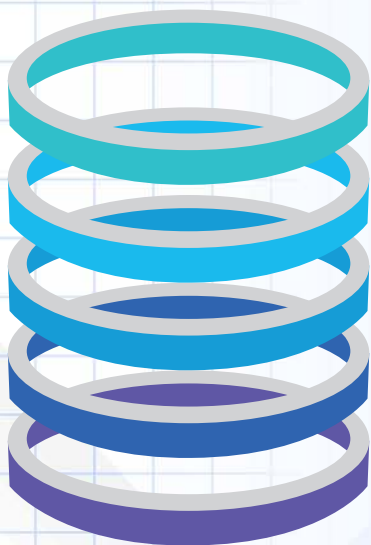

Sale, Purchase & Demolition

Dry Cargo

Tankers

Containers

Other Specialized Sectors

Our database gives access to a varied range of tug owners - both international and local. We have connections in different parts of the world market which provide our clients the most up to date and relevant information.



AVIATION SECTOR

We offer brokerage services, leasing, sales and remarketing of aircrafts and act as intermediaries and negotiators between buyers and sellers while we also engage into supply of aircraft spare parts through our global suppliers.

SERVICES THAT WE OFFER

- ◆ Aircraft Sales & Remarketing
- ◆ Aircraft Leasing & Asset Management
- ◆ Supply Of Aircrafts Spare Parts





Aircraft Sales and Remarketing

- ◆ Development of marketing plan with controlled timeline
 - ◆ Proposal evaluation, term sheet and contract documentation
 - ◆ Technical project management
 - ◆ Co-ordination of project from transaction to closure

Aircraft Leasing & Asset Management

- ◆ Pre-purchase inspections
 - ◆ Preparation & delivery of aircraft to lease
- ◆ Lease monitoring and return

Supply Of Aircrafts Spare Parts

- ◆ Signing up long term contracts for spare parts supply
- ◆ Capture spare parts consumption and thereby formulate consignment options
- ◆ Develop customized services



SOLID WASTE & WATER SUSTAINABLE MANAGEMENT

EPIC's solid waste and water sustainable cluster is built up with two key companies originated from France and Tunisia and having its local offices registered in Oman. Combining as one team we have executed and currently executing several key projects.

We engage into providing engineering services and construction of oil & gas processing plants, solid waste and water treatment plants and industrial plants and various other solutions related to solid waste and water sustainable management.

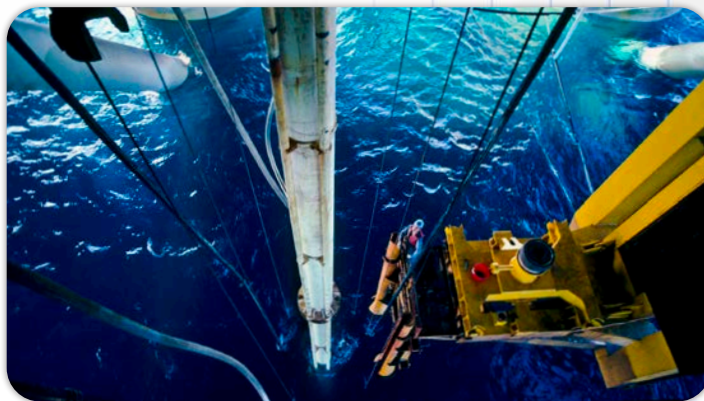

Our key objective is to sustain our client satisfaction and to achieve this objective EPIC's solid waste and water sustainable cluster as a whole works towards deepening its known engineering strategies, by a combination of innovation and advanced technology. Our aim is to be a leading company that provides eco-friendly solid waste and water sustainable management solutions to its customer.

WE OPERATE IN THE
FIELD OF,

1. Oil & Gas

2. Industrial Plants

3. Water Treatment

WE OFFER IN TERMS OF
APPLICATIONS,

- ◆ Reed-bed waste water treatment plants
- ◆ Sludge treatment plants
- ◆ Oil produce water
- ◆ Sewage treatment plants
- ◆ Industrial waste water treatment
- ◆ Grey water recycling
- ◆ Pond water recycling
- ◆ Desalination plants
- ◆ Solid waste treatment plants

WE OFFER IN TERMS OF
SERVICES,

**SOLID WASTE &
WATER SUSTAINABLE
MANAGEMENT**

- Engineering Services
- Design and Build
- Operating and Maintenance
- Procurement
- Plant supply
- Water proofing
- Consultancy Services



INFRASTRUCTURE DEVELOPMENT

EPIC's infrastructure development arm is partnered with **China Communications Construction Company Ltd (CCCC)**.



is one of the leading global infrastructure development company which has a history of over 120 years. Our main aim is to meet the ever growing needs of infrastructure development in the Sultanate of Oman.



Combining as one team we engage into a multitude of infrastructure development projects.

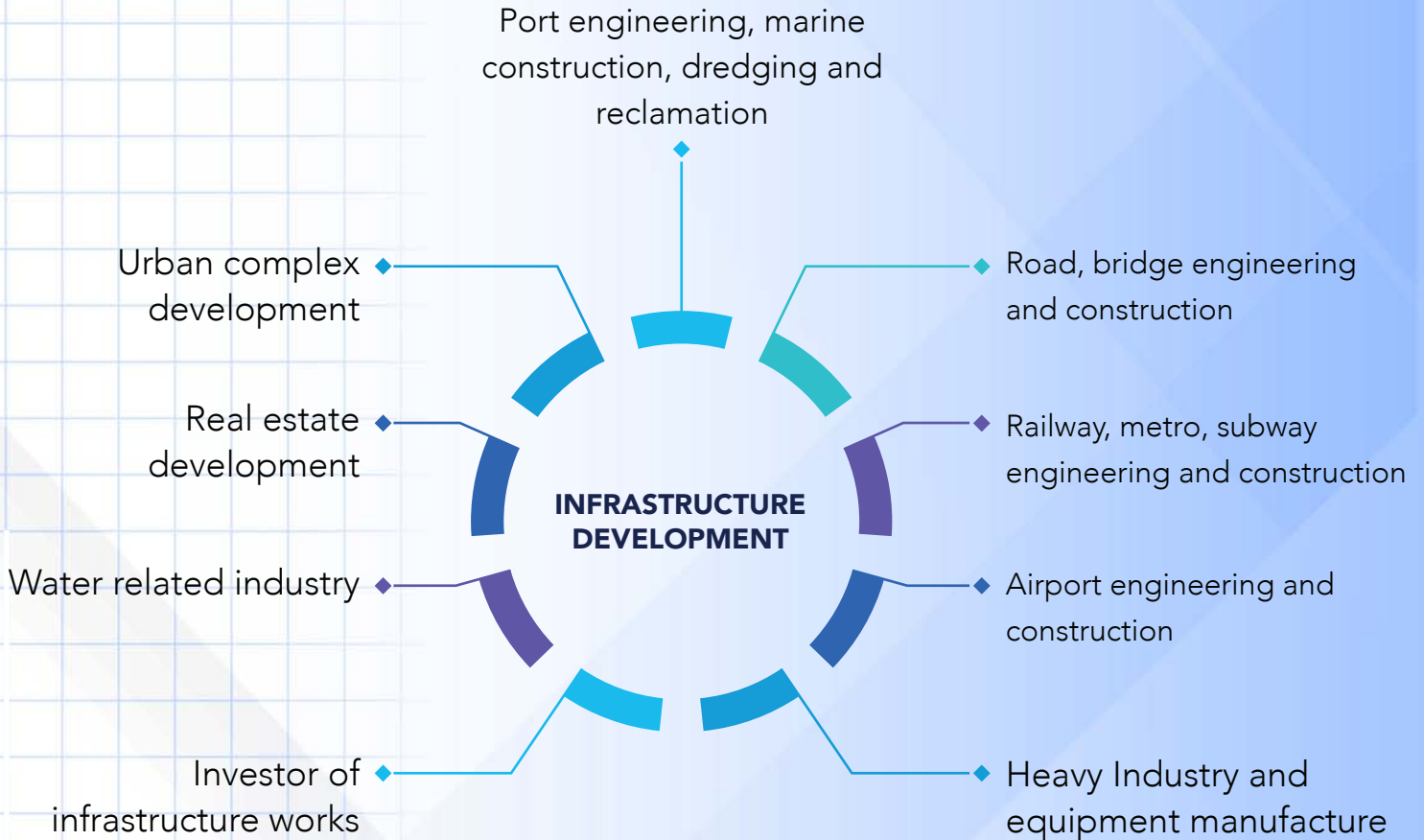

GREEN HYDROGEN

Green Hydrogen provides a significant opportunity to reshape the global energy landscape towards a low carbon and sustainable future. The Sultanate of Oman is committed to net zero emissions by 2050 and aligned with the goals of the 2015 Paris agreement to reduce Greenhouse gas emissions and limit global temperature rise. Oman is naturally endowed with significant wind and world leading solar resources that it plans to develop in order to enable the generation of green hydrogen.



Oman intends to be at the forefront of the development of the Global green hydrogen supply chain and deeply believes in the potential of the eco system from a societal and business perspective which will underpin a transformation across the Oman's economy. The Hydrogen strategy will ensure continued energy independence and security of supply allowing Oman's domestic and the global economy to thrive.

EPIC along with its partner company **GWWT**, plays a focal role in this legacy project as a consortium with some of the leading companies in the world to reshape and build Oman's energy towards Green.



Golden Wellspring Wealth
for Trading LLC

شركة نبع الثراء الذهبية للتجارة ش.م.م



InterContinental
Energy



شركة انرتك القابضة
EnerTech Holding Company



INTRODUCTION TO GROUP OF COMPANIES



مجموعة شركات حسين الحداد
HUSSEIN AL HADDAD GROUP

AL OBAIDANI

GROUP OF COMPANIES

Hussain Al Haddad Trading
And Contracting LLC

اريج الجزيرة للعطور ش.م.م
Areej Al Jazeera Perfumes LLC

Lulu
GROUP INTERNATIONAL

برجيل
burjeel

vps
healthcare

مستشفى خط الحياة
LIFELINE HOSPITAL
THE HEALING TOUCH

Golden Wellspring Wealth
for Trading LLC
شركة نبع الثراء الذهبية للتجارة ش.م.م

نظارات رضوان ع.م.م
Ridhwan Opticals LLC

EPPM
S.A.

ظفار للمعاون ش.م.م
DHOFAR MINERALS L.L.C



**QURIYAT AVIATION
TOURIST RESORT
COMPANY**

**NATIONAL AL
MATLA L.L.C**

**MODERN STATION
TRADING CO.**

AL OBAIDANI
INTERNATIONAL

Al-Obaidani
Logistics LLC
العبيداني للتوريدات ش.م.م

العبيداني

Albaidani
APPARELS

الإبنة للمشاريع والتمويل ش.م.م
WINGS PROJECTS & LOGISTICS LLC

DEYAR

REED BED

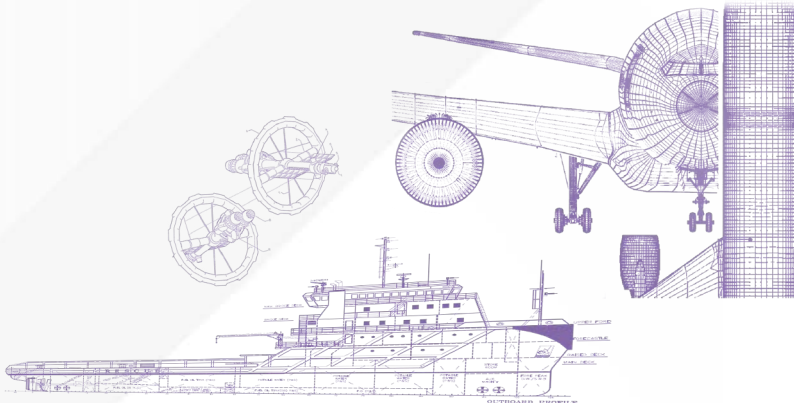
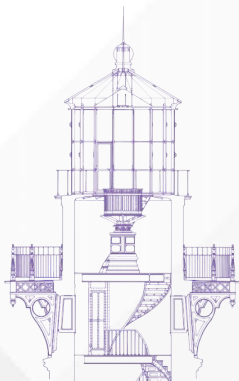
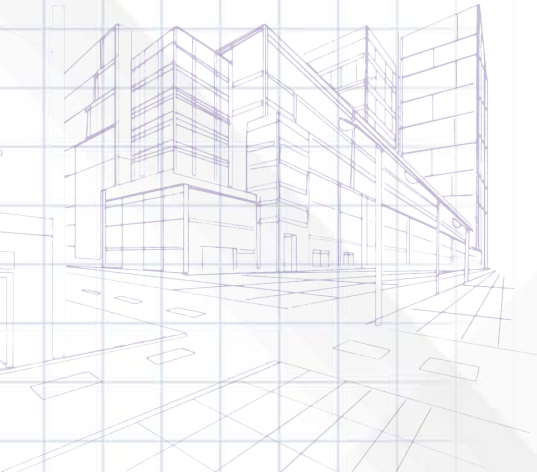



مجموعة شركات حسين الحداد
HUSSEIN AL HADDAD GROUP



Hussain Al Haddad Trading And Contracting LLC

Hussein Al hadad Trading & Contracting L.L.C was established in 2007 as one of certified and qualifies construction companies with the Public Tender Board in Sultanate of Oman.

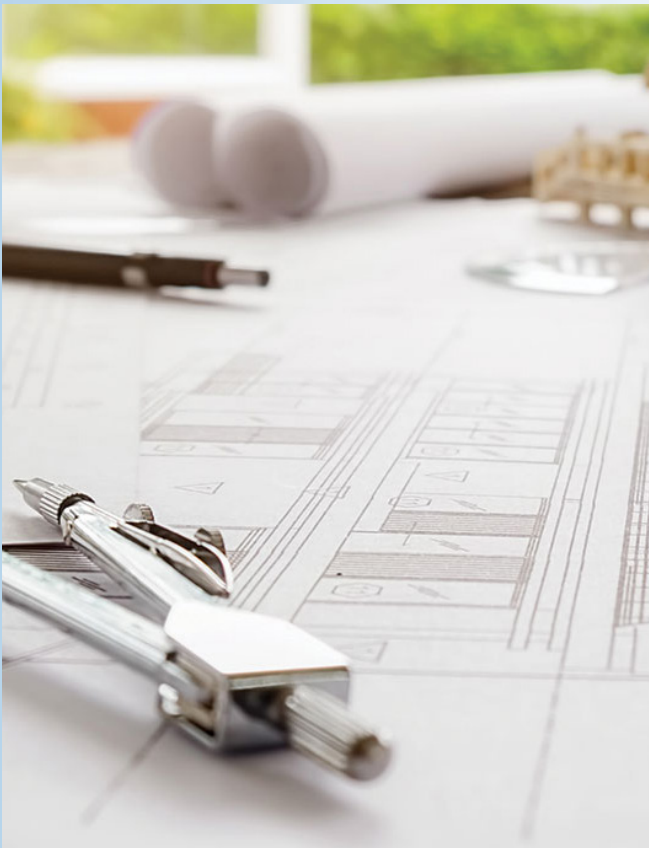

Its one of the specialized companies in multiple general trading activities, besides that the company has a main activity related contracting and construction activities which listed the following:

- Retail and construction materials.
- Jewelries and Gold activities.
- Supermarkets, cold stores.
- Catering Activities.
- Restaurants.
- Contractors and Construction.
- Manufacture of Bakery Products.
- Retail the sport goods.



اريج الجزيرة للعطور ش.م.م *Areej Al Jazeera Perfumes LLC*

Areej Al Jazeera Perfumes L.L.C
Company opened its first exclusive
"Roja Parfums" Boutiques in the year
2014 at "The Royal Opera Galleria"
Muscat, Sultanate of Oman and "Moda
Mall" (Bahrain) in the year 2017.

The company holds the exclusive
rights to distribute "Roja Parfums"
in Oman & Bahrain and in the year
2016 our company also became the
sole distributor for Vertus Perfumes
for Oman, Saudi Arabia & U.A.E and
also for "Ramon Monegal Perfumes"
& "Nicolai Perfumes" for Oman in the
year 2017.

www.reejaljazeeraoman.com



ROJA
PARFUMS





Lulu Group is a highly diversified conglomerate with successful business entities in strategic locations worldwide.

Lulu Group is a world-renowned purveyor of an international business portfolio that ranges from hypermarket operations to shopping mall development, manufacturing and trading of goods, hospitality assets, and real estate.

LuLu Group mainly operates in 22 countries located across the Middle East, Asia, US, and Europe.

<https://www.lulugroupinternational.com/>





برجيل

burjeel

Burjeel Hospital is committed to excellence and delivering outstanding quality in all aspects of the care and services provided.



The Hospital sets a new benchmark for the standard of a private hospital for the people of Oman.

Burjeel Hospital offers all-round expertise, ensuring the best in diagnostic, curative as well as preventative healthcare in over 30 clinical specialties.

<https://www.burjeelhospitaloman.com/bh-oman/>



Services of highly qualified specialists in all the major fields of medicine and surgery, combined with the availability of the most advanced medical equipments makes Lifeline the hospital of choice for the residents of Falaj, Majees and the surrounding port and industrial areas of Sohar.

With a total strength of nearly 50 doctors and 150 support staff, Lifeline Sohar continuously aims to raise the bar in service standards in health care sector in the region.

<https://www.lifelineoman.com/>





Golden Wellspring Wealth for Trading LLC

شركة نبع الثراء الذهبية للتجارة ش.م.م

GWWT is a 100% Omani owned company that plays a key role with one of the country's legacy project that is called as Green Hydrogen (GEO)



GWWT is part of a consortium that will invest in green hydrogen in collaboration with international and local companies, where project investments exceeding \$20 billion.





نظارات رضوان ش.م.م.
Ridhwan Optical L.L.C.

Modern Rudwan Optical is specialized in the Eyeglasses, Sunglasses & Contact Lenses trading and retail.

Modern Rudwan Optical serves its loyal customers through various outlets throughout Muscat and its suburbs and aims to expand its services to reach all customers across Oman.





EPPM is recognized as one of the major EPC contactors active in the Middle East and Africa, operating in Oil & Gas (midstream), Water Treatment, Renewable Energies and Industrial Plants.



EPPM offers to its clients a large range of services including engineering, project management, procurement, construction & supervision, commissioning & start-up as well as operating & maintenance services.

Over the last 25 years of operation EPPM has shown a track record of successfully delivered projects in Engineering, EPCC (turnkey projects), EPS, PMC, O&M, as well as financing projects such as long-term BOT & BOO and leasing projects.

<https://eppm.com.tn/>



ظفار للمعادن ش.م.م
DHO FAR MINERALS L.L.C

The Dhofar Minerals L.L.C,
Specializes on supplier of
gypsum and related products
in the Sultanate of Oman and
GCC countries, the company
has different quarries of
Gypsum and anhydrite, Where
there stockpile gypsum in
quarries of the company's
approximately 40 Million tons.





Oman Portuguese Cement Products LLC

Oman Portuguese Cement products LLC (OPCP), has been established in the Sultanate of Oman in 2008.

The company is a leading manufacturer and seller of concrete blocks, interlocks, kerbstones, ready mix concrete and precast products at Al Batinah and Duqm regions.

The philosophy of the company is structured on principles of innovative approach towards products development, producing consistent quality products, efficient operations, understanding customer's requirements, employee's development, harmony and coordination within teams and their member.

<https://opcpoman.com/>



Bag Filter Company

BAG FILTER is located in MARRAKECH/ Morocco and Oman, its part of the Converted Paper Product Manufacturing Industry. BAG FILTER has 200 total employees across all of its locations and generates \$12.57 million in sales (USD).

Converted Paper Product Manufacturing
Miscellaneous Nondurable Goods Merchant
Wholesalers Chemical and Allied Products
Merchant Wholesalers Health and Personal
Care Stores Corrugated paper: made from
purchased material Nondurable goods,
nec Chemicals and allied products, nec
Orthopedic and prosthesis applications
Orthopedic and prosthesis applications

www.dnb.com/business-directory/company-profiles.bag_filter



QURIYAT AVIATION TOURIST RESORT COMPANY

The Qurayat ITC development will deliver the required infrastructure to boost tourism levels locally and on the international arena, and includes a number of hotels in addition to residential and commercial units, a marina and other supporting facilities.

The Wilayat of Qurayat is one of the major tourist attractions for citizens in Muscat and the neighbouring areas, and is also near to a number of other tourism attractions like Sad Wadi Dayqah, Hawiyat Najm Park, Wadi Shab, and Al Jabal Al Abyadh among others.



MODERN STATION TRADING CO.

Modern Station Trading Co. Specializes in the import and export activities, equipment, goods, machinery and parts of factories.

NATIONAL AL MATLA L.L.C

National Al Matla L.L.C Specializes in sale of new part of equipment's, engines and Vehicles.





AL OBAIDANI

INTERNATIONAL

Established in 2002 Al Obaidani International LLC is recognized as the leading manufacturer of uniform clothing and equipment in Oman and extends its service to the entire GCC. We lead the Uniform, Military clothing and Accessories market with ISO 9001–2015 QMS accreditation.

Our customers include amongst others,

- ◆ Ministry of Defence (MOD)
- ◆ Royal Court Affairs
- ◆ Royal Oman Police
- ◆ Paramilitary forces
- ◆ Ministries of the Royal Government of Oman
- ◆ Prestigious corporate organizations such as
Oman Air
Oman Airports & many more.

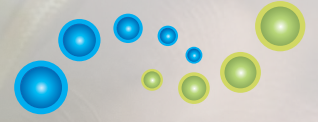

Al-Obaidani
Logistics LLC

العبيداني للتوريدات ش.م.م

Al Obaidani Logistics LLC

The company has a dedicated workforce who strives to create garments that please the taste, preference and style of the Royals. Various types of head gears, decorative badges, belts and other accessories that meet international standards are also supplied.

Established in 2007, Al-Obaidani Logistics LLC has been catering to the specialised requirements of the esteemed client "Diwan of the Royal Court" for nearly a decade. The company has been responsible to ensure the timely supply of high quality tailored garments, uniforms and accessories for the use of the Palace household and staff of various division of the Diwan.



Al Obaidani Stores

العبيداني

Al Obaidani Stores, established for Tailoring Omani Men Dishdasha with small boutique in ancient city call Muttrah in early stages and currently company had expanded its business all over Sultanate with 39 outlets & two modernized factory located in the Capital of Sultanate & Sri Lanka.

Our Products,

- Omani Dishdasha
- Bishoot
- Mussar
- Other GCC Costumes
- Shirt, Coats & Trousers
- Safety Work Wears
- Branding T-Shirts & CAPS
- Fanila



Obaidani Apparels (Pvt) Ltd

Obaidani Apparels (Pvt) Ltd., Established year 2015 in Sri Lanka under Board of Investment of Sri Lanka (BOI). The company begin to cater mainly MENA region since it's mother company located in Sultanate of Oman. The infrastructure developed in factory premises, committed management team, the motivated work force and meeting client's requirements are key features of the company. "Client friendly Environment" is the principal concern of the management of the company.

Specialized products

Our skills in tailoring do not just stop at traditional wear but we are also masters of business, formal shirts and trousers. We use our skill, experience and attention to detail to make sure that even our modern and contemporary Western garments are customized to every aspect of your needs. The products are as follows,

- Formal Shirts
- Casual Shirts
- Uniform Shirts
- Formal Pants
- Casual Chinos
- Cargo Pants
- Polo T Shirts
- Crew Neck T shirts
- School Unifroms

- Formal Skirts
- cropped Pants
- 3/4 Pants
- Formal Blouses
- Casual Blouses
- Tank Tops
- Coveralls
- Omani Dishdasha
- Shorts for Mens & Womens





 الأجنحة للمشاريع والتمويل لش.م.م.
WINGS PROJECTS & LOGISTICS LLC

Wings Projects & Logistics LLC was set up in 2013 to provide a complete uniform solutions service from concept development to completion across the full range of hospitality industries.

We believe in developing strong relationships with our clients and focus on delivering customized solutions based on individual client's needs. We guarantee that each project we undertake will offer a courteous and professional service and will fulfill to deliver results to the complete satisfaction of our customer.





Having established in the year 2007, DEYYAR INTERNATIONAL LLC is a Contracting and Maintenance Company specialized in engineering, project construction, painting and maintenance activities across Marine, Oil & Gas and Refineries.

Deyyar International LLC

We provide various services and solutions to clients in various sectors which are broadly categorized as follows

- Marine
- Oil & Gas
- Energy
- Civil and Construction
- Water Management

<https://www.deyyarint.com/#home>



REED BED

Having established in the year 2016, Reed Bed Contracting offers its expertise in water sustainable management and acts as an EPC company.

Reed Bed Contracting LLC

Solutions are,

- Wetland Rehabilitation
- Sewage Treatment Plant
- Sludge Treatment Plant
- Produced Oil Water
- Industrial Waste Water
- Grey Water Recycling
- Pond Water Recycling
- Green Roof

<http://reedbed.om/about-us/>

EPIC

